

# LUBRICATION CHART

FOR

10", 13", 16" & 16-24" LATHES

AND

10", 13", & 16" Turret Lathes

HELPFUL SUGGESTIONS FOR THE PROPER MAINTENANCE OF YOUR LATHE WHICH WILL HELP TO PROLONG THE ORIGINAL ACCURACY, ITS SERVICEABLE LIFE AND ITS EASE OF OPERATION.

## SET-UP PROCEDURE

1. Look carefully in all packages for small parts, instruction material, etc.
2. Study all reference books and instruction sheets carefully.
3. Clean lathe thoroughly.
4. Mount on a substantial floor, preferably concrete.
5. Level lathe. (See instructions inside)
6. Lubricate lathe. (See lubrication chart inside)

## OPERATIONAL MAINTENANCE

1. Keep your lathe clean.
2. Keep your lathe lubricated as recommended.
3. Keep belts clean and properly adjusted at all times.
4. When your lathe is setting idle keep it covered with one of our service covers. Write for accessory catalog.
5. Recheck lathe leveling periodically.



**South Bend Lathe Corp.**

*Precision Machine Tools Since 1906*

# BELT CARE AND MAINTENANCE

The Flat Belt on your lathe has been especially selected for its special quality and elasticity to transmit power efficiently and will give excellent service if kept clean and the tension properly adjusted. The performance of your lathe will depend greatly on the condition and tension of the belts on your lathe. If your lathe has lost its pulling power, your Flat Belt is probably slipping because the tension is not great enough, or the Flat Belt may be worn out or oily. Many believe that the Flat belts that are used on lathes should last forever, but belts wear out the same as other moving parts. When the Flat Belt has become oil soaked or stretched it should be replaced with a new Flat Belt.

## SUGGESTIONS

1. Keep Flat Belt clean. Remember, belts wear out. They cost little. Use the recommended Flat Belt and replace as frequently as necessary.
2. Maintain proper Belt tension.
3. Do not run Lathe with too much tension on belt.
4. Release Belt Tension Lever, taking strain off Belt when Lathe is not operating.
5. When ultimate of belt tension adjustment has been reached, replace with new Flat Belt. Order the correct belt from your nearest South Bend Distributor or direct from our factory.

## BELT ADJUSTMENTS

**CONE PULLEY BELT**—Belt tension release lever "A" permits releasing cone pulley belt tension for shifting belt to change spindle speeds. Screw "C" adjusts tension of the cone pulley flat belt. This adjustment must be made with lever "A" in the down position.

**MOTOR V-BELT**—Screw "B" adjusts tension of the motor V-belts. Turn nuts above and below motor mounting plate.

Belts should be just tight enough to transmit the required power without slipping. Pressing the hand against a properly adjusted flat belt near the cone pulley should depress belt about  $\frac{1}{2}$ ". The V-belt, midway between pulley, should depress about 1". Belts may be cleaned with naphtha or benzol.

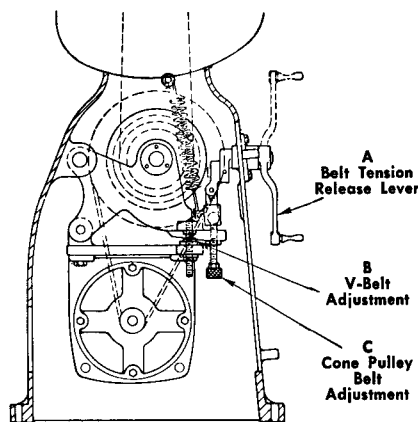

Cross Section of Underneath Belt Motor Drive Showing Cone Pulley Belt and V-belts

Maintaining the proper running tension for the flat belt and V-belts is very important. Belts which are allowed to run loose will creep and slip and cause an over-all loss in the cutting efficiency of the lathe. Belts which are run under too much tension, overload the lathe and lathe drive. This results in loss of power, excessive bearing wear, causes the motor to run hot, and abnormal stretching of flat belt. Routine checking and adjustment of the belt tension, according to instructions, will keep the lathe efficiency high and repair expenses low.

# LEVELING THE LATHE

The correct installation and leveling of the lathe is more important than is generally realized. Precision tolerances can be maintained only when the lathe is mounted on a solid foundation and properly leveled according to the following instructions.

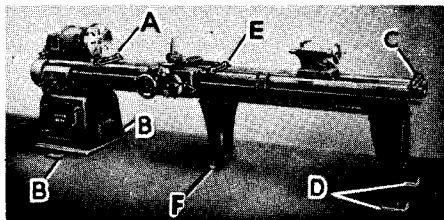

## FOR LATHES WITHOUT TAILSTOCK LEVELING LEG SCREWS (With or Without Center Leg)

1. Clean all dirt, chips, etc., from bed ways.
2. Place precision level squarely across V-ways at "A". (Use South Bend 12" Precision Level, Cat. No. CE2218, or equal.)
3. Drive shims\* under cabinet leg at "B" until bubble on the level is approximately central. Carefully note the exact position of the bubble in relation to graduations on the level.
4. Move level and place squarely across V-ways at "C". Do not turn level end for end.
5. Drive shims\* under leg at "D" until bubble comes to rest at exactly the same position in relation to graduations as when level was at "A".
6. Repeat steps 2, 3, 4, and 5, until level readings at "A" and "C" are identical.
7. For 10', 12' and 14' lathe beds with center leg, move level and place directly over center leg at "E" using saddle wings to position level at right angle to bed ways.
8. Adjust the elevating screws at "F" until level reading is the same as when level was at "A" and "C". Do not hump center of bed when adjusting center leg leveling screws.
9. Repeat steps 2, 3, 4, 5, 7, and 8, until level readings are identical at points A, C, and E.
10. Fasten Legs at "B" and "D" only, to floor.
11. Check again at "A" and "C" (also at "E" if lathe has center leg) to see if level readings have remained the same. If not, the leveling procedure must be repeated. **THE LEVEL READINGS SHOULD BE EXACTLY ALIKE AT ALL POSITIONS AFTER THE LATHE IS FASTENED TO THE FLOOR, OTHERWISE THE LATHE WILL NOT TURN OR BORE ACCURATELY.**

## FOR LATHES WITH TAILSTOCK LEVELING LEG SCREWS

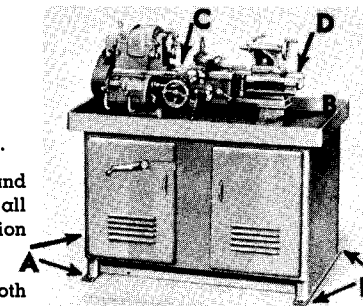

1. Clean all dirt, chips, etc., from bed ways.
2. Drive shims\* under each leg pad at "A" and "E" so lathe will set firmly on floor at all four points, removing any rocking motion under the legs.
3. Loosen the leveling leg screws at "B", both front and rear screws.
4. Place precision level squarely across V-way at "C" (Use South Bend 12" Precision Level Cat. No. CE2218 or equal).
5. Adjust shims under leg pads at "A" until bubble on the level is approximately central, carefully note the exact position of the bubble in relation to graduations on the level.
6. Without turning level end for end, move level and place squarely across V-ways at "D".
7. Adjust shims under leg pads at "E" until bubble comes to rest at the same position as when level was at "C".
8. Repeat steps 4, 5, 6, and 7, until level readings at "C" and "D" are approximately the same.
9. Fasten to floor.
10. Adjust the Tailstock leg leveling screws at "B" until level readings at "C" and "D" are exactly the same. Then lock leveling screws.
11. **CAUTION—THE LEVEL READINGS SHOULD BE EXACTLY ALIKE AT BOTH POSITIONS AFTER THE LEGS ARE FASTENED TO THE FLOOR, OTHERWISE THE LATHE WILL NOT TURN OR BORE ACCURATELY.**

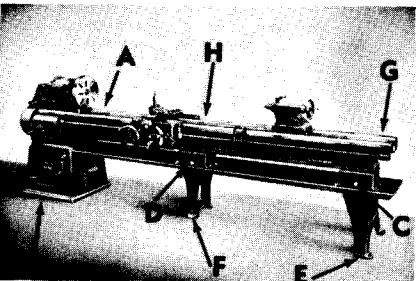

## FOR LATHES WITH TAILSTOCK LEVELING LEG SCREWS (With or Without Center Leg)

1. Clean all dirt, chips, etc. from bedways.
  2. Place precision level squarely across V-ways at "A". (Use South Bend Precision Level, Catalog No. CE2218 or equal.)
  3. Drive shims under cabinet leg "B" until bubble on level is approximately central. Carefully note the exact position of the bubble in relation to graduations on the level.
  4. Loosen leveling leg screws both front and rear at "C" (also "D" if with Center Leg.)
  5. Drive shims under leg pad "E" so lathe will set firmly on floor at points "B" and "E".
  6. Move level and place squarely across V-ways at "G". Do not turn level end for end.
  7. Adjust leg leveling screws at "C" until bubble comes to rest at exactly the same position as level readings at "A".
  8. For lathes with 10', 12' and 14' beds. Move level to "H" squarely across V-ways using saddle wings to position level at right angle to bed way. Adjust the elevating screws at "F" so lathe will set firmly on floor. Do not hump center of bed when adjusting these screws.
  9. Adjust center leg leveling screws at "D" until level reading is the same as when level was at "A" and "G".
  10. Repeat steps 2, 3, 5, 6, 7, 8, 9 until reading at "A", "H" and "G" are identical.
  11. Fasten legs at "B" and "E" only, to floor.
  12. Check again at "A", "H" and "G" to see if level readings have remained the same. If not, the leveling procedure must be repeated.
- NOTE—THE LEVEL READINGS SHOULD BE EXACTLY ALIKE AT ALL POSITIONS AFTER THE LATHE IS FASTENED TO THE FLOOR; OTHERWISE, THE LATHE WILL NOT TURN OR BORE ACCURATELY.**

# LUBRICATION

FOR 10", 13", 16" & 16/24"

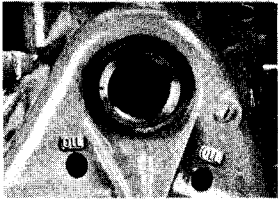

Oiling Points for 10" & 16" Lathe twin gears

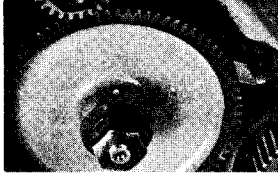

Oiling point for primary idler gear

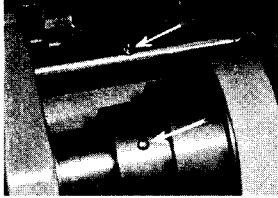

Teflon Grease Lubricant ROY DEAN #DE112

LUBRICATE ANNUALLY  
order from  
SOUTH BEND LATHE.  
Cat. No. CE1625  
or  
ROY DEAN PRODUCTS COMPANY  
23440 Kean  
Dearborn, Michigan 48124



Drain and flush apron every 3 months

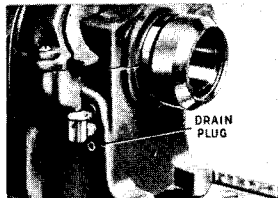

Drain and flush headstock every 3 months

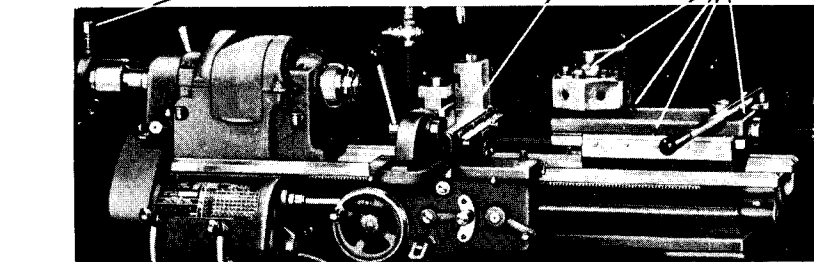

Additional Points of Oiling on 10" Turret Lathes

Reverse Bracket  
TYPE OIL "C"  
Fill Daily

Spindle Bearings  
TYPE OIL "A"  
Keep Full

Teflon Grease Lubricant  
ROY DEAN #DE112

Spindle Threads  
TYPE OIL "C"

Taper Att.  
TYPE OIL "C"  
Oil Daily

Twin Gears  
TYPE OIL "C"  
Oil Daily

Gear Box  
TYPE OIL "B"  
Fill Daily

Idler Gear  
TYPE OIL "C"  
Oil Daily

Tension Lever  
TYPE OIL "C"  
Oil Daily

Gear Reduction  
TYPE OIL "B"  
Keep Full  
16/24" Only

Motor  
Sleeve Bearings  
TYPE OIL "A"  
Oil Monthly

Ball Bearings  
If Motor Has  
Grease Fittings  
Use Ball Bearing  
Grease  
Every 2 Years

Collet Att.  
TYPE OIL "C"  
Keep Full

Feed Screw  
TYPE OIL "C"  
Oil Daily

Turret  
TYPE OIL "C"  
Oil Daily

LUBRICATE ANNUALLY  
order from  
SOUTH BEND LATHE.  
Cat. No. CE1625  
or  
ROY DEAN PRODUCTS COMPANY  
23440 Kean  
Dearborn, Michigan 48124

Micrometer Stop  
TYPE OIL "C"  
When Used

PUMP OIL CAN. Suitable for lubricating all types of machinery. Has large nonclogging pump tube. Cone tipped spout seats in oil hole forces oil into bearings and prevents spilling. Hook on tip for opening spring cap oil cups. Holds 7/8 pint and has 6" spout. CE3575. Pump Oil Can. Shipping weight 11lb.

**SBU**  
South Bend

400 West Sample Street  
219-289-7771 • FAX 219-289-7772

# N CHART

24" AND TURRET LATHES

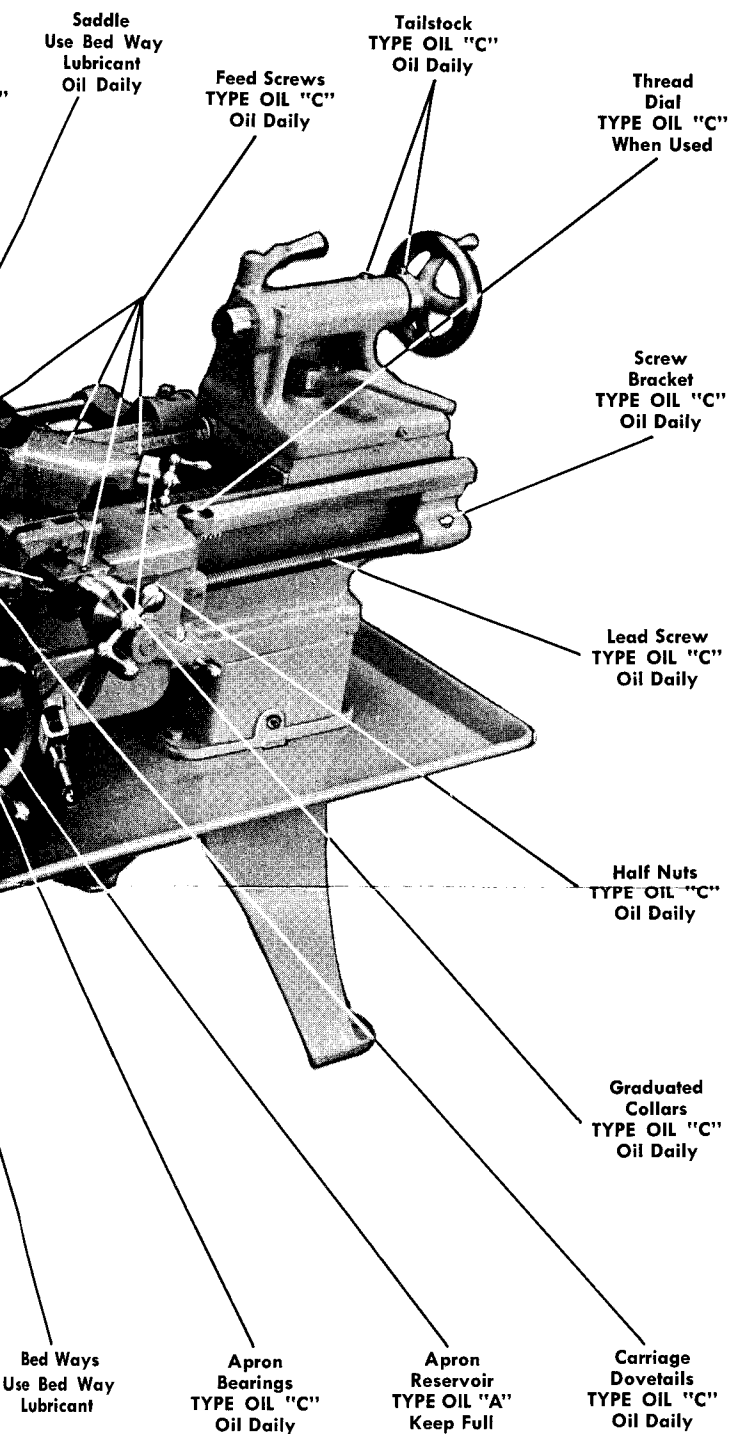

## LUBRICATING OIL SPECIFICATIONS

MACHINE OIL SAYBOLT UNIVERSAL VISCOSITY RATING IN SECONDS AT 100° F.			
COMPANY NAME	TYPE A: 100 SEC.	TYPE B: 150-240 SEC.	TYPE C: 250-500 SEC.
South Bend Lathe, Inc.	Qt. can—CE1600 Gal. can—CE2017	Qt. can—CE1602 Gal. can—CE2018	Qt. can—CE1603 Gal. can—CE2019
Cities Service	Sentry Oil #2	Sentry Oil #5	Sentry Oil #8
Gulf	Gulcrest 41	Gulf Harmony 44	Gulf Harmony 53
Mobil	Velocite Oil 10	Gg. Vactra Oil Light	Gg. Vactra Oil Heavy Medium
Phillips	Condor Lubricating Oil 1002	Condor Lubricating Oil 1004 Condor Lubricating Oil 1006	Condor Lubricating Oil 1008 Condor Lubricating Oil 1010
Pure	Spindle Oil D	Puropale Medium	Puropale Heavy Medium
Shell	Shell Vitrea Oil 923	Shell Vitrea Oil 27	Shell Vitrea Oil 33
Sinclair	Cadet Oil A	Warrior Oil	Commander Oil B
Standard of (Ind.)	Superla Spindle Oil C	Indoil #15	Indoil #31
Sun	Solnus 100 Sunvis 11	Solnus 150 Sunvis 16 Solnus 200 Sunvis 21	Solnus 300 Sunvis 31 Solnus 500 Sunvis 51

Bed Way Lubricant (Viscosity 300-500). South Bend Lathe. Catalog No. CE1671, 12 oz. can.  
Open Gear Spray Lubricant - Recommended for gearing not running in oil, and is effective in reducing gear noise. South Bend Lathe. Catalog No. CE1605. 12 oz. can.

### TYPICAL RECOMMENDED LUBRICANTS

This is only a partial listing of the many oil companies and their grades of machine oils that conform to our specifications. You may use this chart for comparison purposes to procure the proper grade of machine oil from any oil company of your own preference.

If source of supply is not available in your area, contact your nearest South Bend Lathe Distributor or order direct from factory at South Bend. Oils developed for automobile crank case lubrication are not recommended for machine tool lubrication.

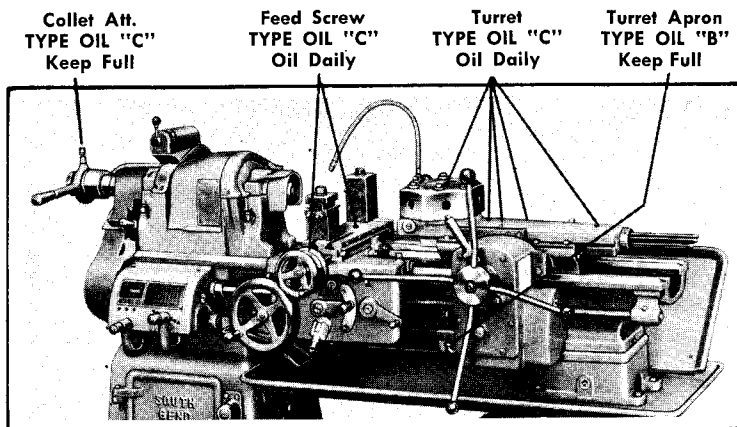

Additional Points of Oiling on 13" Turret Lathes

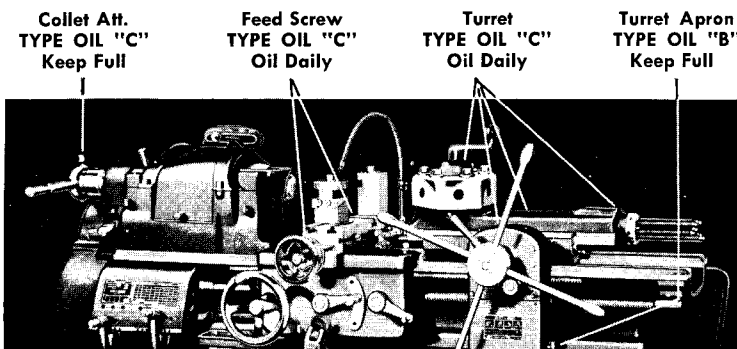

Additional Points of Oiling on 2H Turret Lathes

Oiling Directions as Indicated are for an 8 hr. shift. When used for longer periods, each operator should oil machine.

South Bend Lathe Corp.

South Bend • South Bend, IN 46601 • U.S.A.  
Tel. 219-236-1210 • 1-800-24-LATHE

Printed in U. S. A.

FOR MORE INFORMATION ON REQUEST - ASK FOR CHART 6514