

# DESCRIPTION OF SHAPER TOOL HOLDERS AND SHAPER TOOLS

Unit 1-T52(C) Parts I and II Pages 151 to 166

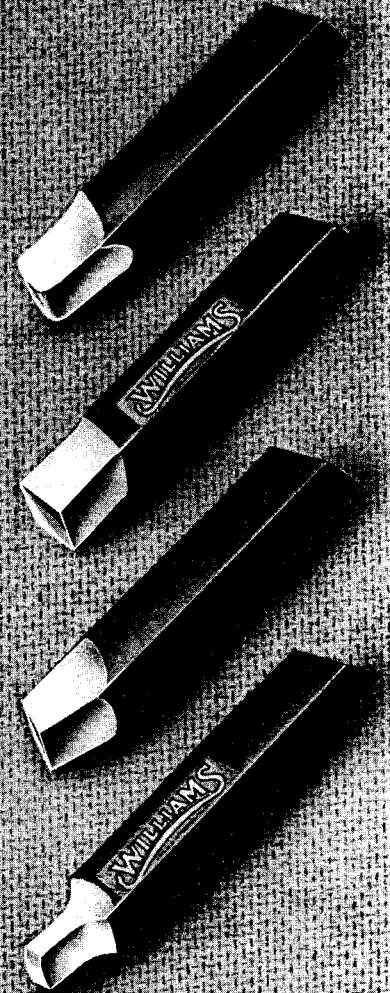
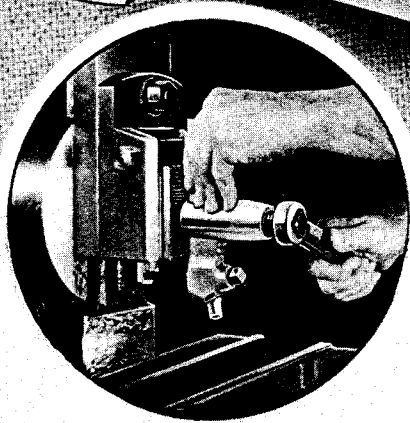

Photo by courtesy of J. H. Williams & Co.



UNIVERSITY OF THE STATE OF NEW YORK  
STATE EDUCATION DEPARTMENT  
BUREAU OF INDUSTRIAL AND TECHNICAL EDUCATION

# DESCRIPTION of SHAPER TOOL HOLDERS

## OBJECTIVES OF UNIT

1. To explain the terminology used in connection with tool holders.
2. To describe the various types of tool holders used for shaper work.
3. To become familiar with manufacturers' designations of tool-holder styles.

### INTRODUCTORY INFORMATION

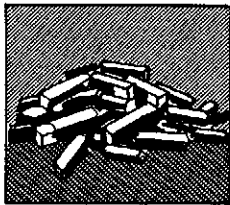

The introduction of tool holders instead of solid forged tools into the machine-tool industry was principally a matter of economy. The first attempts to hold tools in holders, although ingenious, allowed the tool to slip under heavy cuts and often lacked the rigidity so necessary for general use.

As a result of the introduction of more expensive steels for cutting tools, much money was invested in the production of costly forged tools, and considerable time was required to forge, grind, and shape these tools. In addition, waste was unavoidable, for when the tools became too short to be held in the machine they were discarded and eventually scrapped.

Gradually, as improvement in the designs of tool holders has been made, the use of these devices has been extended. Now, as a result of improved designs, tools are securely and solidly held, grinding has been reduced to a minimum, forging is unnecessary, and waste has been reduced considerably. Although proportionately larger and stronger tool holders are designed to be used in the larger machines, solid tools are still extensively used in the heavy machine-tool industries.

In addition to the standard tool holders, there are those which can be purchased in sets. The sets contain a number of standard tools or bits which fit into a special holder. A set of these cutters is adequate for the usual shaper operations, but extra cutters usually may be purchased, and special ones can be made to order.

The American Society of Mechanical Engineers has adopted a set of definitions which apply to all single-point tools, including tool holders. As these definitions have not been adopted by all users and manufacturers, the student should take particular notice of how the terms are applied in each case.

DESCRIPTION OF TOOL HOLDERS

SIZE AND STYLE

To the shaper operator, the size of the tool holder depends principally upon the size of the shank which will fit into the tool post of the machine. It is also necessary for the operator to decide whether or not the tool holder should be straight or offset, right-hand, or left-hand, and to select the style of holder to suit the shape of the tool.

The straight-shank tool holder (Fig. 200) holds the tool parallel with the sides of the tool holder in contrast to the bent style (Fig. 201) which holds the tool at an angle with the sides. These tool holders also may be left or right, depending upon the inclination of the tool either to the left or to the right of the work.

According to the American Standard as issued by the American Society of Mechanical Engineers and published in the American Machinists' Handbook, "A bent tool has the point bent to the left or right (Fig. 201) to make its operation more convenient. These tools are called left-bent tools if the point is bent to the left when looking at the tool from the point end with the face upward and the shank pointing away, and vice versa."

As a tool holder can be classified as a tool shank, this definition can be applied to a tool holder. Conventional usage, however, has not yet entirely adopted the definition, and for this reason four examples of two leading tool-holder manufacturers' products are shown in Fig. 202.

It should be noticed also that the term offset, instead of bent, is used to describe these holders.

The tool holder shown at A is designated as a right-hand offset tool holder; the one illustrated at B is a left-hand offset. The tool holder shown at C which holds a side-cutting tool is

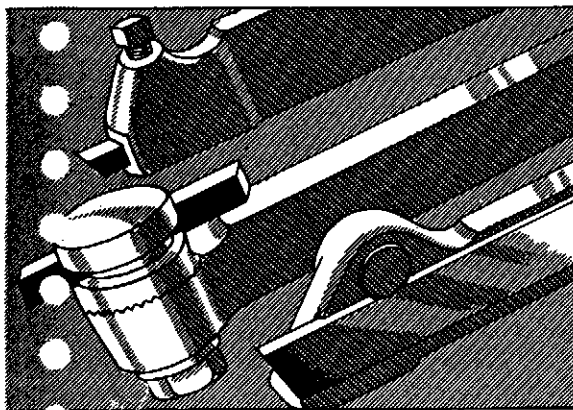

FIG. 200

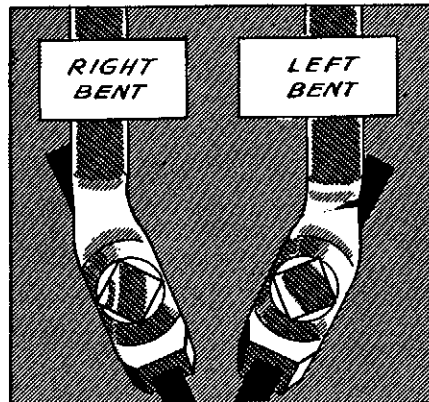

FIG. 201

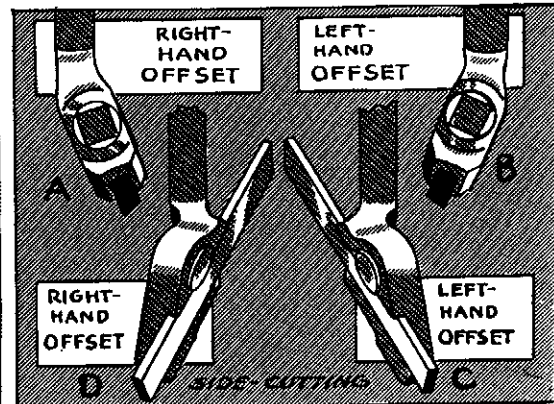

FIG. 202

also a left-hand offset holder, although it is bent in the direction opposite to that of B. Notwithstanding that the tool holder is "bent" to the opposite side compared with the one portrayed at B, the tool which it holds will cut on the same side of the work. The tool holder shown at D is correspondingly a right-hand offset side-cutting tool holder.

The style of tool holder is also influenced by the cross-sectional shape of the tool (Fig. 200). It is understood, of course, that the tool is selected first to suit the style of cut, the nature of the material, and the kind of work.

Tool holders are designated by a manufacturers' number, usually with a letter placed either before or after the number or, in other instances, a letter may be placed both before and after the number. The letter S, R, or L after the number indicates that the holder is straight, right-hand, or left-hand; the letter before the number frequently is the manufacturer's identification of the style of cutter. For example, a designation T-2-S would indicate that the tool holder is to be used to hold a 3/8" square tool bit and has a 5/8" x 1-1/2" x 8" straight shank. This would fit in a tool post with a maximum tool capacity of 7/8" x 1-1/2".

#### TYPES OF TOOL HOLDERS

Tool holders may be classified according to the method of holding the tool in relation to the shank of the holder: (1) those which hold the tool parallel (horizontal) with the shank of the holder; (2) those which incline the tool at a slight angle with the shank; (3) those which incline the tool at a steep angle with the shank.

Each of the three holders illustrated in Fig. 200 is designed to hold the tool parallel with the shank of the tool holder. The tool to be used in these three tool holders is ground to the required shape and with the necessary clearances, and unless the tool is held parallel, the angle at which the point of the tool is presented to the work will be changed and the clearances also will vary.

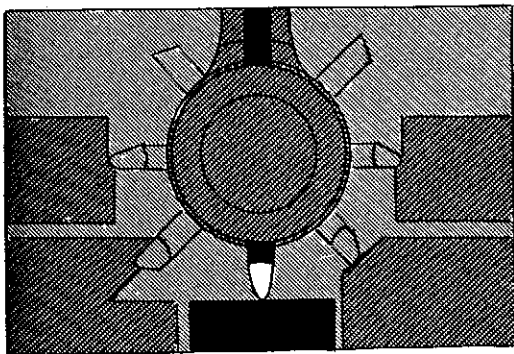
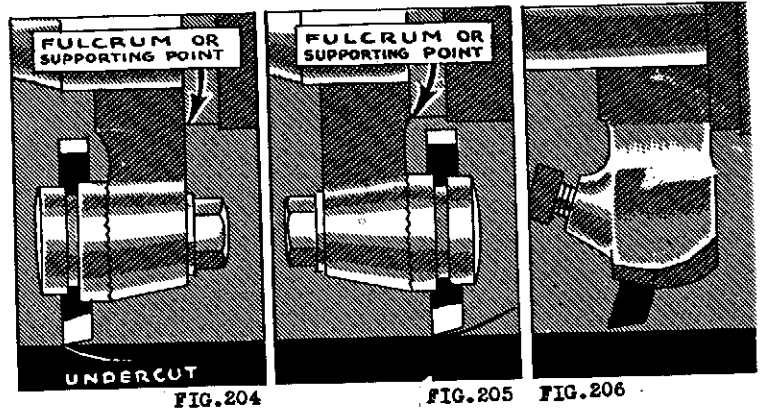

FIG. 203

An exceedingly handy device is the shaper-and-planer tool holder shown in Fig. 203. The tool is held parallel with the shank, but may be set at almost any angle to cut on the right- or left-hand side of the work. The tool holder may be held in the shaper in the conventional manner (Fig. 204) with the cutting edge ahead of the supporting surface, or the tool holder may be turned around to act as a gooseneck tool with the cutting edge behind the fulcrum (Fig. 205). In the former case, the tool has a tendency to spring into the

work when cutting, whereas the spring of the tool is away from the work when it is held in the latter position.

As the tool is held parallel with the shank of the tool holder, the clearances and angles are easily determined and ground without having to take into consideration the inclined angle of the tool (Fig. 206).



In this second group of holders the tool is inclined at a slight angle. The slight angle at which the tool is held, called the tool-holder angle, should be such that it will eliminate, as much as possible, grinding the top of the tool. For shaper work, a satisfactory tool-holder angle is  $15^{\circ}$  (Fig. 206), the grinding in this case being mostly to give the tool both front and side clearance.

The remaining two examples in this classification (Fig. 207) incline the tool at a steep angle which should correspond to the most satisfactory clearance angle for the front of the tool. This type of tool holder, however, is not extensively used for general shaper work, but it has some merit when used to hold formed tools. The tool in this case can be ground on the top without changing the contour of the tool if the top surface is always ground at the same angle.

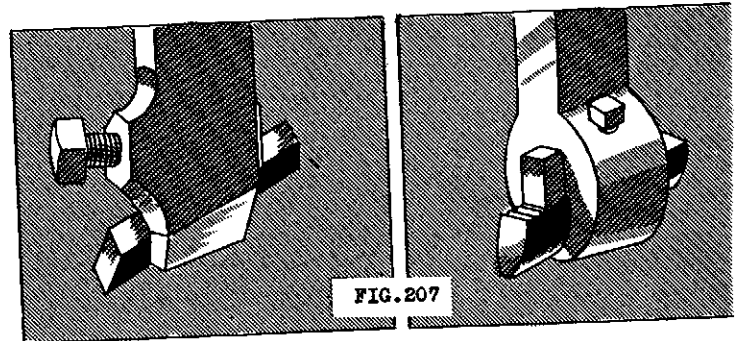

### CLAMPING METHODS

Two principal methods are used to clamp the tool in the shaper tool holder: first, a direct clamping action caused by the pressure of a screw; second, a wedging action produced either by a cam or by a drawbolt.

An example of the first method is shown in Fig. 208. A tool is inserted in a rectangular or square hole in the front of the holder and is forced down by the direct pressure of the screw.

In the second case, the tool is

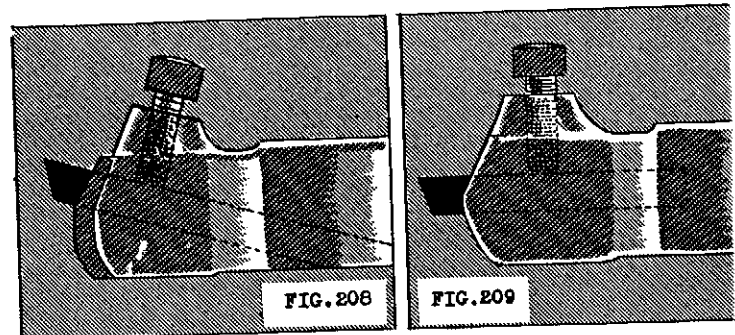

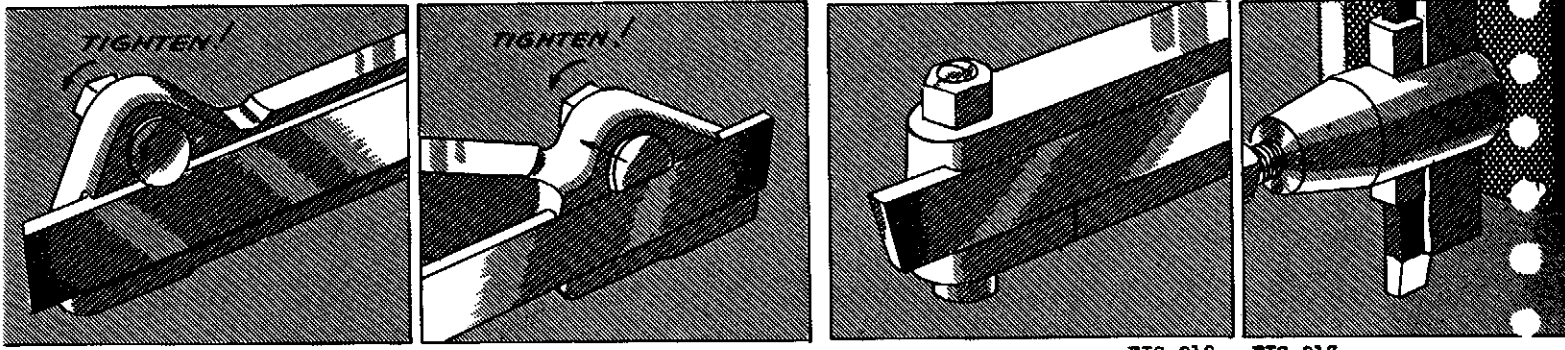

FIG. 210 FIG. 211

FIG. 212 FIG. 213

wedged against the bottom ledge of the tool holder by a cam action (Fig. 210). As the cam is turned with a wrench it presses downward against the tool in such a direction that, as the cutting action of the tool tends to force the tool into the tool holder, it wedges tighter as the pressure increases. The tool can be easily released by turning the cam in the direction opposite to that indicated by the arrow.

The drawbolt is another adaptation of the wedging action which also can be used very effectively with flat tools (Fig. 211). The cutter is placed in a slot in the side of the tool holder and is held in position with a tapered-head bolt with a flat side. As the bolt is drawn in, the tapered surface forces the bolt downwards and the pressure of the flat side of the head on the tool holds it in place.

Fig. 212 and Fig. 213 illustrate two other methods of holding the tool in the tool holder.

There are also on the market patented sets of tools and tool holders which have many convenient features. The set illustrated in Fig. 214 is made especially for shaper work by the "OK" Tool Company.

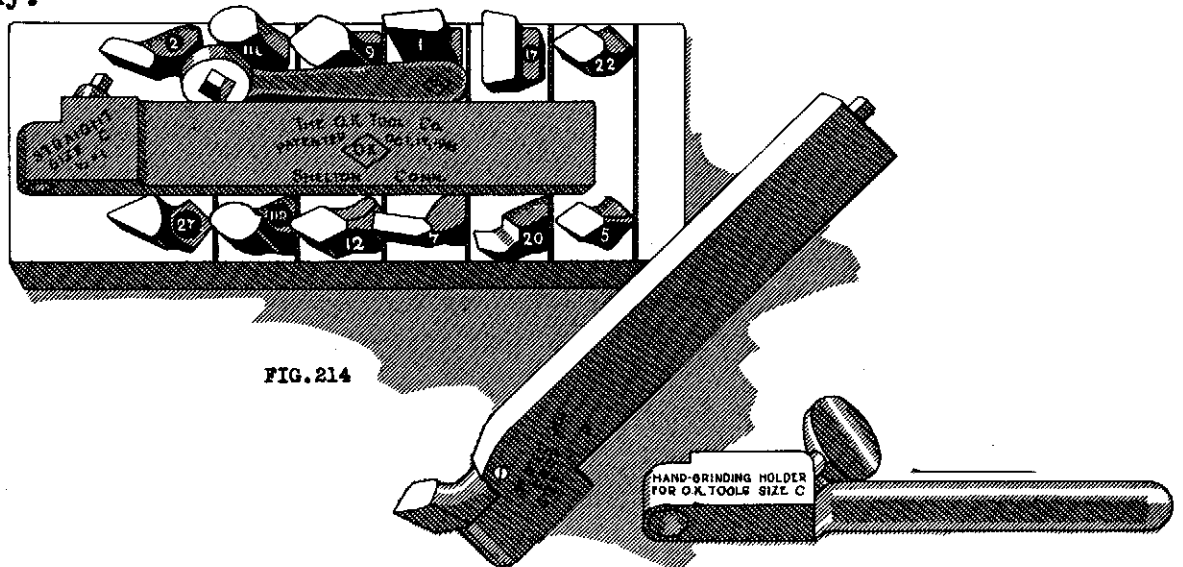

FIG. 214

# DESCRIPTION *of* SHAPER TOOLS

## OBJECTIVES OF UNIT

1. To understand the terminology used in connection with cutting tools.
2. To become familiar with the various shapes of tools.
3. To visualize and understand the angles of clearance, the angles of rake, and the lip angle of the tool.

### INTRODUCTORY INFORMATION

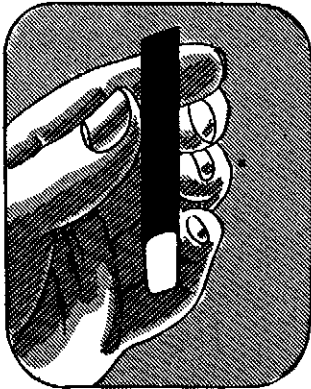

Tools used in the shaper may be forged or ground to shape from solid steel bars or they may be smaller pieces of steel which are held and clamped in a tool holder.

The shape of the tool varies considerably with the character of the work. To give examples of the various shapes of tools for every purpose and at the same time to satisfy every individual mechanic's preference for form would take up more space than is allotted in this monograph. In addition, the terms applied to single-point tools and tool holders are not entirely consistent. Although attempts have been made to standardize these terms, conventional usage so far has frustrated the attempts to apply them in every case.

There are certain principles, however, which the beginner must understand before he can use and grind cutting tools intelligently. For example, a tool may cut very satisfactorily for general work, but may not be satisfactory for sustained, heavy-duty production cuts.

The same caution should be observed in this section regarding terminology as was observed in the section dealing with tool holders. The terms adopted by the American Standards Association have not been accepted by all users and manufacturers, and, therefore, some explanation may be necessary when standard terms differ from those in conventional use.

It should be understood that changes of this character take time and often require considerable expense on the part of manufacturers. Eventually, however, that which is best for the industry as a whole will finally be adopted.

### CUTTING TOOL TERMINOLOGY

The shaper tool, or cutter, is a piece of high-grade steel which is shaped, hardened, and ground to a cutting edge. It is securely held in the tool head of the shaper and made to pass across the work and take a series of cuts.

The tools may be forged from steel bars or they may be smaller pieces of steel inserted in a tool holder. The cutters are usually square or rectangular in shape, except in cases where tools are made in sets to fit special types of tool holders.

The shape, or form, of the tool depends chiefly upon the shape of the cut, although it is influenced by the kind of finish required and the kind of material to be machined; the rake, the cutting angle, and the clearances, on the other hand, depend principally upon the nature of the material. All of the foregoing considerations are governed by certain basic underlying principles which have been determined as a result of experimentation and observation.

A discussion of tools is better understood if some of the terms used to describe these tools are defined. The following American Standards' definitions apply to some of the more common terms used in connection with single-point cutting tools. A more complete list of definitions will be found in the American Machinists' Handbook.

POINT - The point is all that part of the tool which is shaped to produce the cutting edges and face (Fig. 215).

SHANK - The shank is that part of the tool on one end of which the point is formed or the tip or bit is supported. The shank in turn is supported in the tool post of the machine (Fig. 215).

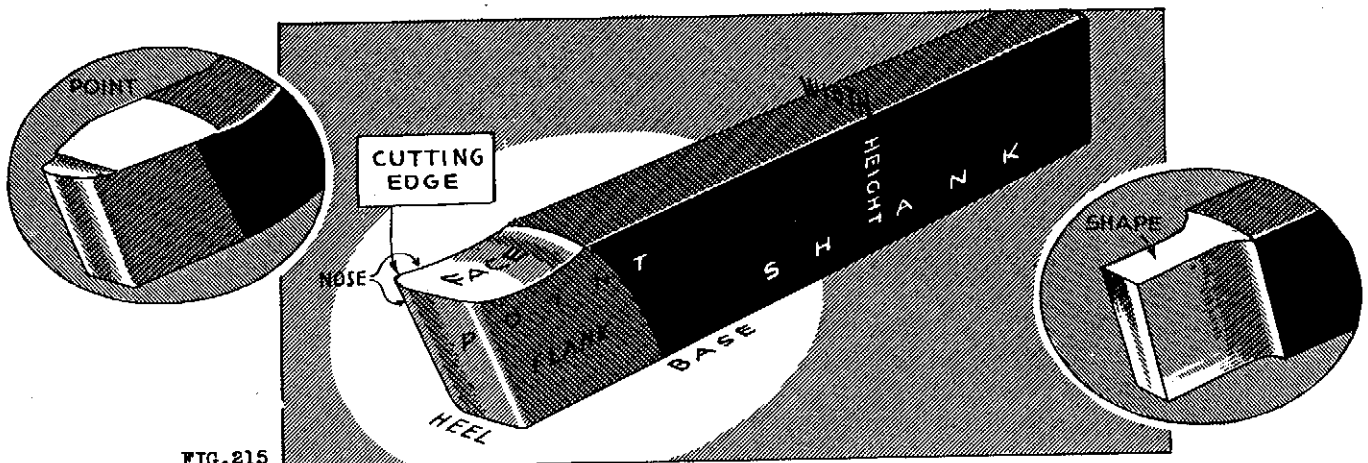

FIG. 215



FACE - The face is that surface on which the chip impinges as it is cut from the work (Fig. 215).

CUTTING EDGE - The cutting edge is that portion of the face edge along which the chip is separated from the work. The cutting edge consists usually of the side-cutting edge, the nose radius, and the end-cutting edge (Fig. 215).

SHAPE - The shape of the tool is the contour of the face when viewed in a direction at right angles to the base (Fig. 215).

WORKING ANGLES - The working angles are those angles between tool and work which depend not only on the shape of the tool, but also on its position with respect to the work.

CUTTING ANGLE - The cutting angle is the angle between the face of the tool and a tangent to the machined surface at the point of action. It equals  $90^\circ$ , minus the true-rake angle (Fig. 216).

LIP ANGLE - The lip angle is the included angle of the tool material between the face and the ground flank measured in a plane at right angles to the cutting edge. When measured in a plane perpendicular to the cutting edge at the end of the tool, it is called the end lip angle. When measured at the point of chip flow, it is called the true lip angle (Fig. 217).

BACK-RAKE ANGLE - The back-rake angle is the angle between the face of a tool and a line parallel to the base of the shank or holder measured in a plane parallel to the center line of the point and at right angles to the base. The angle is positive if the face slopes downward from the point toward the shank and is negative

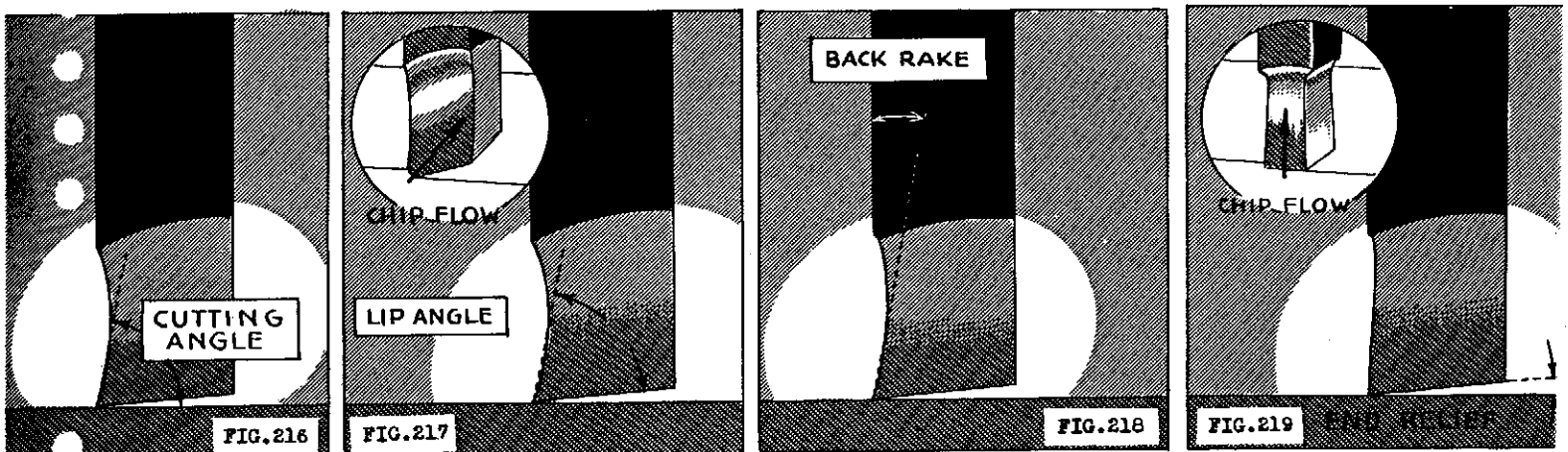

if the face slopes upward toward the shank (Fig. 218).

END-RELIEF ANGLE - The end-relief angle is the angle between the portion of the end flank immediately below the cutting edge and a line drawn through that cutting edge perpendicular to the base. It is measured in a plane parallel to the center line of the point (Fig. 219).

SIDE-RELIEF ANGLE - The side-relief angle is the angle between the portion of the flank immediately below the cutting edge and a line drawn through this cutting edge perpendicular to the base. It is measured in a plane at right angles to the center line of the point (Fig. 220).

SIDE-RAKE ANGLE - The side-rake angle is the angle between the face of a tool and a line parallel to the base. It is measured in a plane at right angles to the base, and at right angles to the center line of the point (Fig. 220).

TRUE-RAKE ANGLE - The true-rake angle (or "top-rake"), under actual cutting conditions is the actual slope of the tool face toward the base from the active cutting edge in the direction of chip flow. It is a combination of the back-rake and side-rake angles and varies with the setting of the tool and with the feed and depth of cut (Fig. 221).

RIGHT-CUT TOOL - A right-cut single-point tool is one which, when viewed from the point end of the tool, with the face up, has the cutting edge on the right side (Fig. 223).

LEFT-CUT TOOL - A left-cut tool has the cutting edge on the left when looking at the point end with the face upward (Fig. 222).

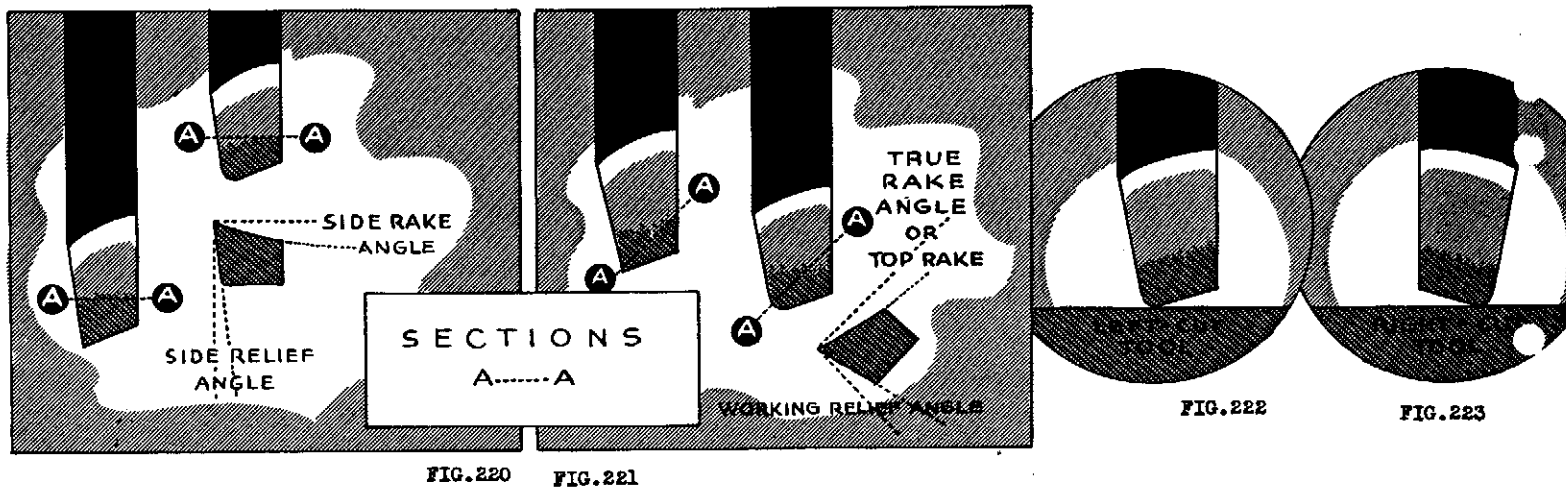

BENT TOOL - A bent tool has the point bent to the left or right to make its operation more convenient. These tools are called left-bent tools if the point is bent to the left when looking at the tool from the point end with the face upward and the shank pointing away, and vice versa (Fig. 224).



FIG. 224

SIDE-CUTTING-EDGE ANGLE - The side-cutting-edge angle is the angle between the straight side-cutting edge and the side of the tool shank. In the case of a bent tool this angle is measured from the straight portion of the shank (Fig. 225).



END-CUTTING-EDGE ANGLE - The end-cutting-edge angle is the angle between the cutting edge on the end of the tool and a line at right angles to the side edge of the straight portion of the tool shank (Fig. 225).

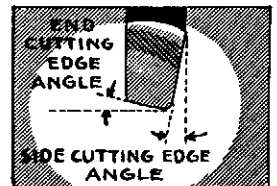

FIG. 225

THE SHAPE OR FORM OF THE TOOL AS VIEWED FROM THE TOP

The shape of the tool may be curved, flat, or its sides may converge to a sharp point. The form of the tool will depend principally upon the surface being machined. For example, a tool with a curved surface could not be used to produce a rectangular slot or to produce a sharp corner, and, in contrast, a tool with a sharp corner would not be recommended for a curved surface or for roughing a flat surface.

Usually there is a difference between the roughing and the finishing tool; in addition, a tool may be offset, or bent, to the right or to the left and may feed either in a right-hand or left-hand direction.

A tool with a rounded nose may be used to rough out both steel and cast-iron surfaces, and with slight modification may be used to produce a finish cut. Frequently, the shear-cut tool (Fig. 226) is preferred for finishing steel, whereas a tool with a flat end shaped as in Fig. 227 is extensively used to finish cast iron.

The three tools illustrated in Fig. 228 should give satisfactory results when used in the shaper to produce flat horizontal surfaces.

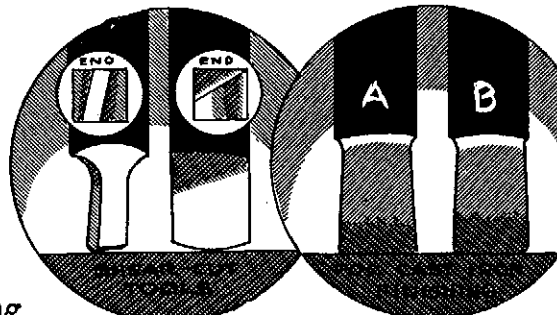

FIG. 226

FIG. 227

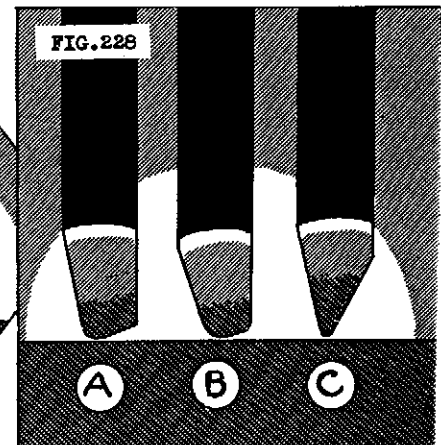

FIG. 228

The tool shown at A is recommended for roughing cuts. It has a side-cut-

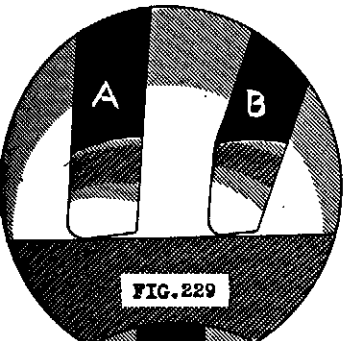

FIG. 229

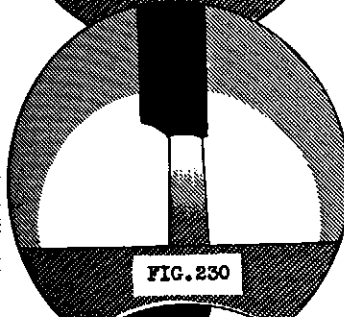

FIG. 230

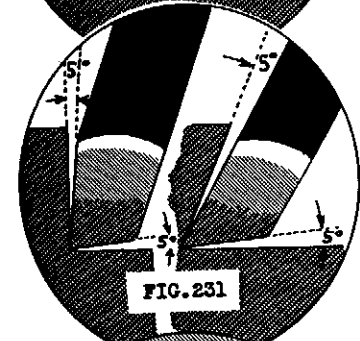

FIG. 231



FIG. 232

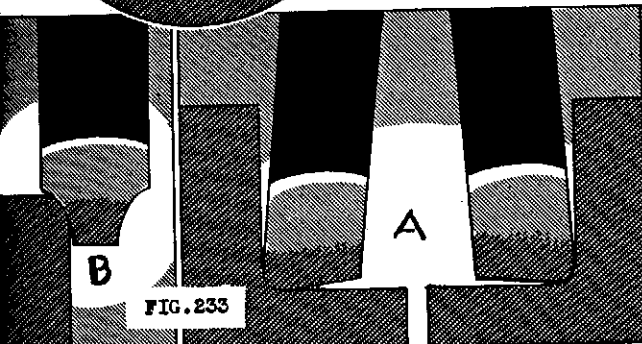

FIG. 233

ting-edge angle of  $8^{\circ}$ , an end-cutting-edge angle of  $15^{\circ}$ , and a  $1/16''$  radius on the nose of the tool. The slight variation of the round-nosed tool shown at B is preferred by many for roughing cuts. It has a side cutting-edge angle of  $20^{\circ}$  and a large radius on the nose. The large radius on the nose is often objectionable when this tool is used for fine cuts, roughing out radii, and in other instances where a broad surface on the tool is likely to produce chatter. This may be overcome by using a tool with a small radius as illustrated at C.

Similar in shape to the tool for shaping horizontal surfaces is the roughing tool for down, or vertical, cutting (Fig. 229). The tool is ground to an angle of about  $85^{\circ}$  with a small radius on the nose. The side cutting edge should be parallel with the side of the tool A or may be offset slightly B to give clearance for the tool holder.

For finishing cast iron, the tool A (Fig. 227) is extensively used and will give excellent results. The corners of the tool may be sharp or they may be rounded slightly as in B.

Whenever it is desired to finish the surfaces of steel, the shear-cut tool (Fig. 226), when used with a little coolant, will produce a smooth, bright finish. (Refer also to Fig. 248.)

In addition to being used to finish cast iron, the square-nosed tool (Fig. 230) can be used to cut slots and to cut off material. The tool is made considerably narrower when used to cut off material, and is ground to the desired width for cutting slots.

A tool that is used to finish square or acute angular corners is ground as in Fig. 231. This tool is ground at an angle from  $5^{\circ}$  to  $10^{\circ}$  less than the angle of the corner which it is intended to cut. As the extreme point of this tool will break down easily, it is not suitable for roughing cuts. For roughing, the nose of the tool should be rounded (Fig. 232).

Convenient tools for rounding the edge or for cutting the radius of a corner formed by two  $90^{\circ}$  surfaces are the radius tools (Fig. 233). These tools are made in two styles, male and female, to suit either an inside or an

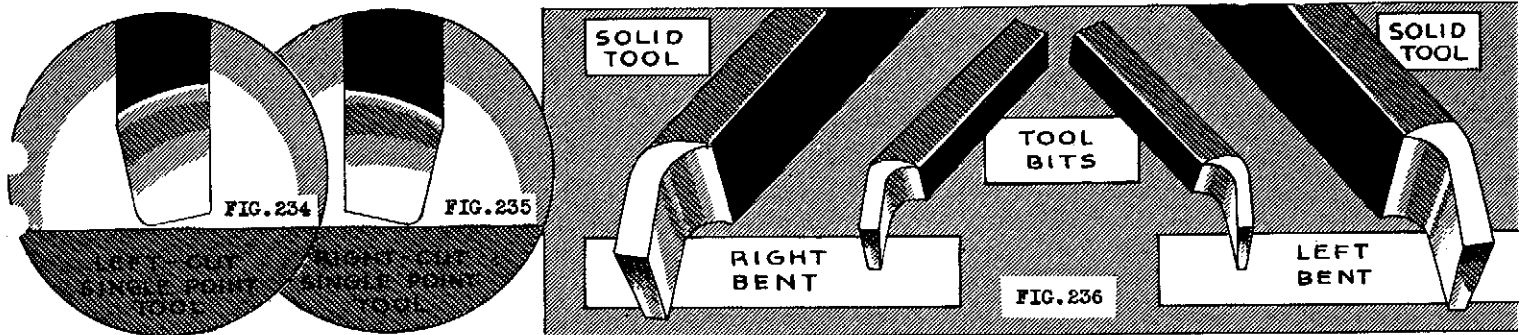

outside radius. The male radius tool **A**, should be ground at an angle of about  $85^\circ$  to give enough clearance for the sides when the inside radius is being cut. Frequently this radius can be cut out with the nose of the round-nosed roughing tool. The corners of the female radius, tool **B**, also should be given a slight relief to prevent it from cutting into the adjoining flat surfaces.

As it is necessary at times to shape both sides of a job without taking the work out of the vise or the machine, tools are made to cut on the right-hand or left-hand side of the work. These tools are referred to as right-hand or left-hand tools, or right-cut or left-cut tools.

According to the American Standard Association definition, "A right-cut single-point tool is one which, when viewed from the point end of the tool, with the face up, has the cutting edge on the right side" (Fig. 234). "A left-cut tool has the cutting edge on the left when looking at the point end with the face upward" (Fig. 235).

Here again, we find that terminology and use of shaper tools are not entirely consistent with these definitions. Some manufacturers still prefer to designate these in the opposite manner.

The same situation exists with the bent tools. In American Standard terminology, right and left single-point tools are designated as in Fig. 236. At the same time, some users still favor the old method of naming them oppositely.

This situation always exists whenever terminology is changed or standardized. The important characteristics, nevertheless, of the tool, such as clearance, rake, cutting angles, and shapes, seem fairly well established and, after all, these are the important features to the shaper operator.

#### CLEARANCE, RAKE, AND LIP ANGLE

The purpose of clearance, both on the side and the end of the shaper tool, is to allow the cutting edge to do the cutting and the back of the cutting edge to clear the work.

It should be realized that the shaper tool does not feed sideways

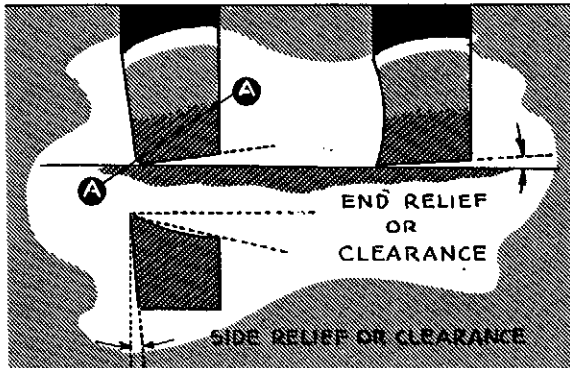

FIG. 237

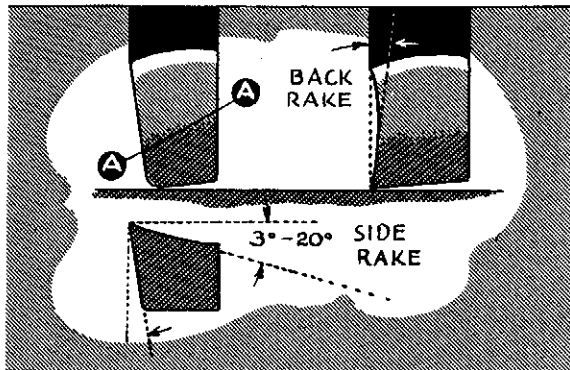

FIG. 238

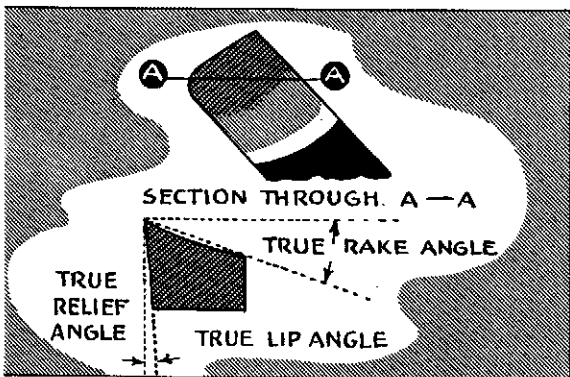
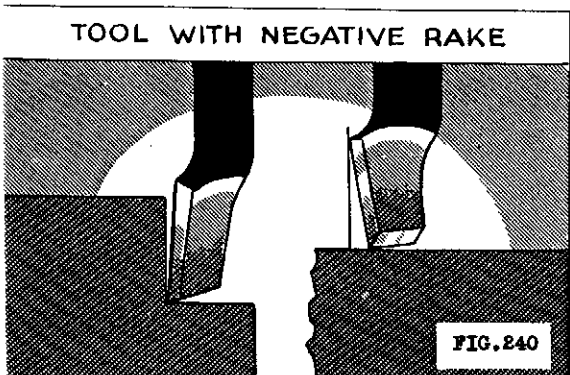

FIG. 239



into the work during the actual cutting; therefore, a clearance of  $2^{\circ}$  to  $6^{\circ}$  with an average of  $4^{\circ}$  is usually considered adequate clearance for the side and the end of the tool. The effective clearance would, in the case of a round-nosed tool, be a combination of the side and front clearance measured at the nose of the tool (Fig. 239).

The side slope and back slope, or side rake and back rake (Fig. 238) are more subject to variation than the front and side clearances. It is the amount of side and back rake which has the greatest influence upon the true lip angle of the tool (Fig. 239).

Theoretically, the rake should be ground on the tool to reduce the amount of power required for cutting and to reduce the wear resulting from the enormous pressure required to peel off the chip. On the other hand, the least possible rake should be given in order to support the cutting edge and prevent it from wearing and crumbling away.

Thus we are confronted with two opposite requirements, one which requires the edge to be as sharp as possible, and the other which tends to avoid a sharp cutting edge. The amount of rake must be determined then as a compromise between the above two opposite requirements. The tool should be sharp enough to cut with maximum efficiency, but at the same time blunt enough to support the cutting edge sufficiently and yet produce the desired finish on the various metals.

With the foregoing principle in mind, the student should realize that no set rake is satisfactory for all metals and under all conditions. Some very satisfactory results, however, have been obtained with the following rake angles: for steel, a side rake of  $10^{\circ}$  to  $20^{\circ}$  and a back rake of  $2^{\circ}$  to  $8^{\circ}$ ; for cast iron, a side rake of  $3^{\circ}$  to  $10^{\circ}$  and a back rake of  $0^{\circ}$  to  $3^{\circ}$ .

Occasionally, a side-cutting tool may be given a negative rake (Fig. 240). As the tool moves forward it first strikes the work above the extreme point, softening the blow slightly and reducing the tendency to break off the

tip of the tool.

As mentioned previously, the lip angle of the tool is influenced by the amount of rake and the clearance of the tool. For instance, if a tool has  $3^{\circ}$  clearance on the side and a side slope of  $15^{\circ}$ , the lip angle at that point will be  $72^{\circ}$  (Fig. 241).

These tools are ground to be used with a tool holder which holds the tool parallel (horizontal) with the shank (Fig. 245).

Often the only type of tool holder available is one which will hold the tool at a  $15^{\circ}$  angle of inclination (page 155). This angle must be taken into consideration when the tool is ground. If the tool is inclined  $15^{\circ}$  in the tool holder and a  $3^{\circ}$  relief angle (front clearance) is required,  $15^{\circ}$  plus  $3^{\circ}$ , or an  $18^{\circ}$  relief angle must be ground on the end of the tool in order to compensate for the  $15^{\circ}$  slope and to give  $3^{\circ}$  clearance (Fig. 242).

The same procedure must be followed in regard to the back rake of the tool. Since the tool is set at  $15^{\circ}$ , the back slope will also be  $15^{\circ}$ , and this, with a  $3^{\circ}$  relief, will give a lip angle of  $72^{\circ}$  (Fig. 243). If for cutting cast iron a back relief of  $2^{\circ}$  were required, then the cutter would be ground on the tip to a lip angle of  $85^{\circ}$  (Fig. 244).

The side relief and the side rake are also affected by the  $15^{\circ}$  inclination, but not in the same proportion as are the end relief and the back relief.

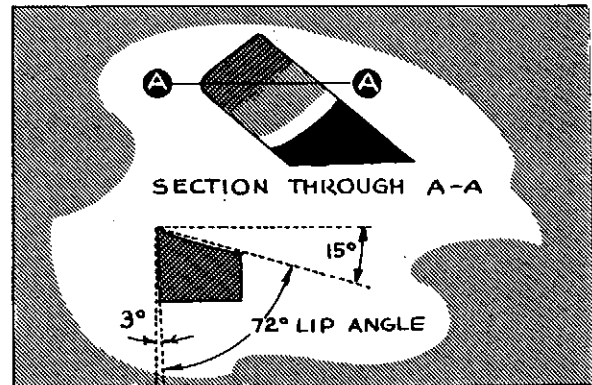

FIG. 241

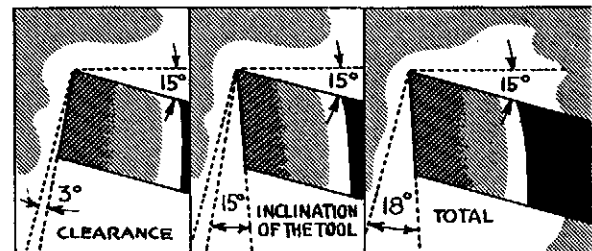

FIG. 242

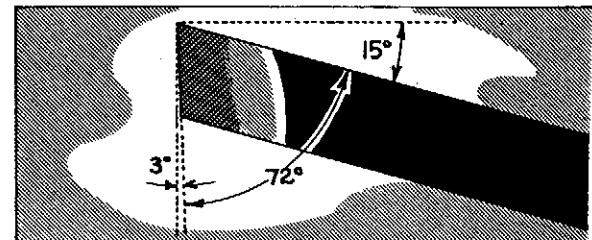

FIG. 243

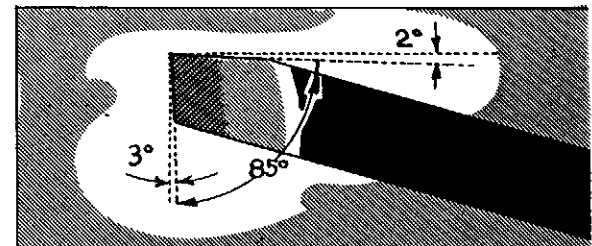

FIG. 244

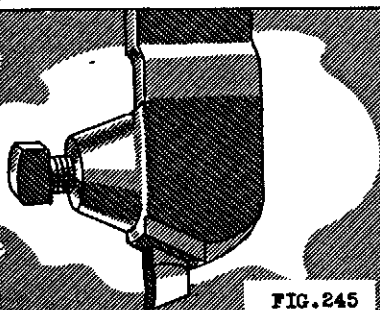

FIG. 245

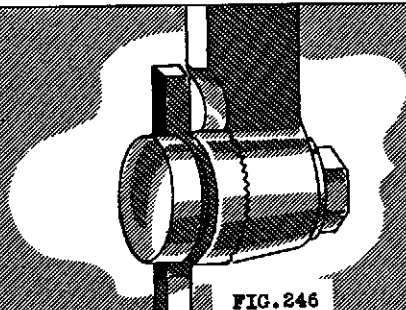

FIG. 246

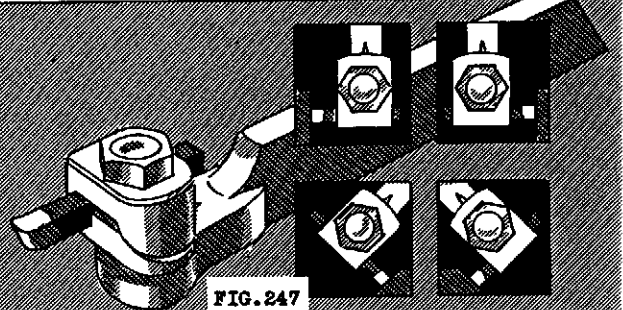
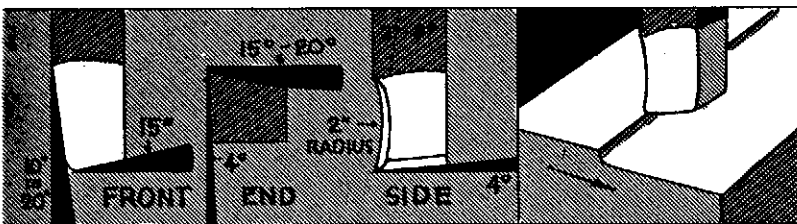

FIG. 247

The following tools are designated to conform to the terminology of the American Standards Association definitions. The indicated cutting angles and the clearances are to be used when the tool is held parallel (horizontal) with the shank of the holder.

LEFT-CUT ROUGHING TOOL FOR STEEL



LEFT-CUT ROUGHING TOOL FOR CAST IRON

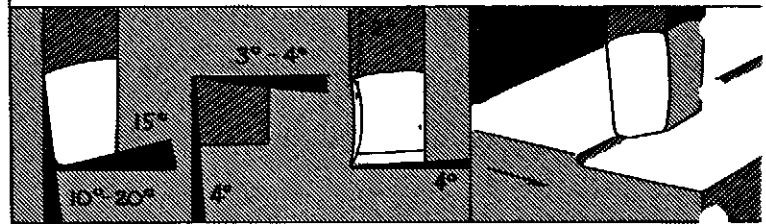

LEFT-SIDE CUT TOOL FOR STEEL

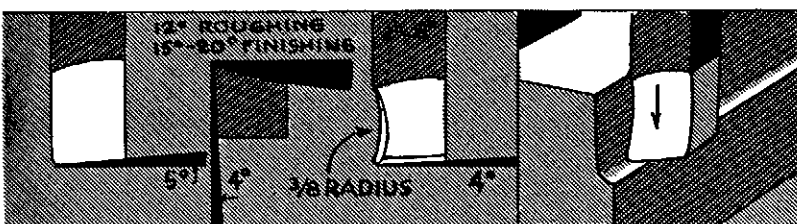

LEFT-SIDE CUT TOOL FOR CAST IRON

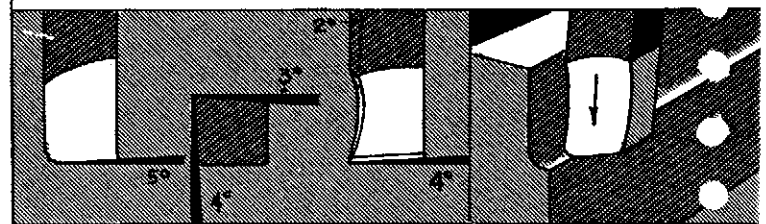

FINISHING TOOL FOR CAST IRON - CORNERS MAY BE ROUND

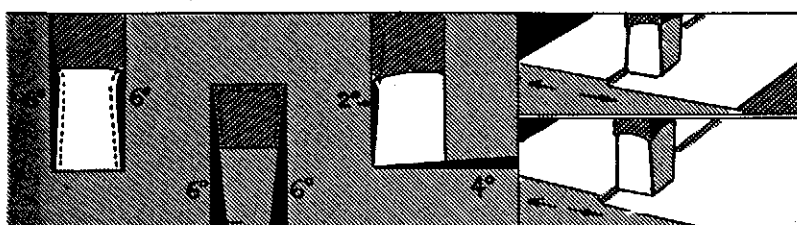

SIDE-CUTTING TOOL FOR SQUARING CORNERS

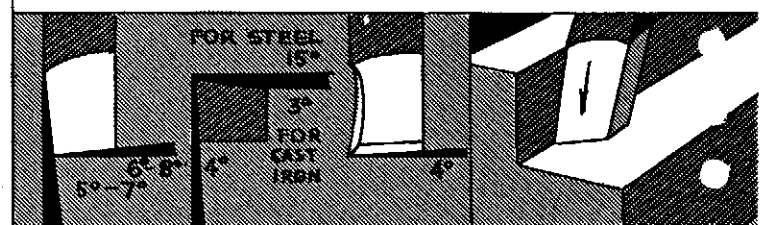

ROUND-NOSED TOOL FOR LIGHT FINISHING CUTS ON STEEL

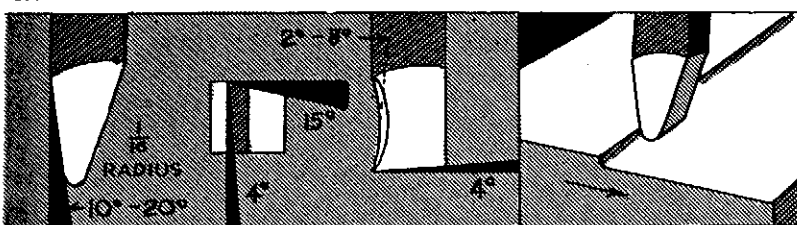

ROUND-NOSED TOOL FOR BRONZE OR BRASS

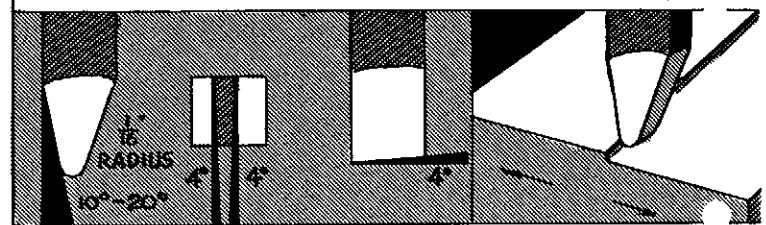

SHEAR TOOL FOR FINISHING STEEL

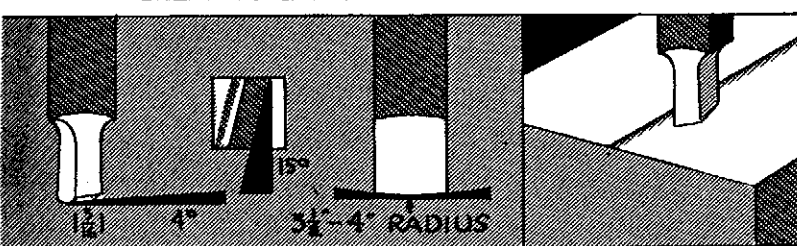

CUTTING-OFF AND SLOT-CUTTING TOOL

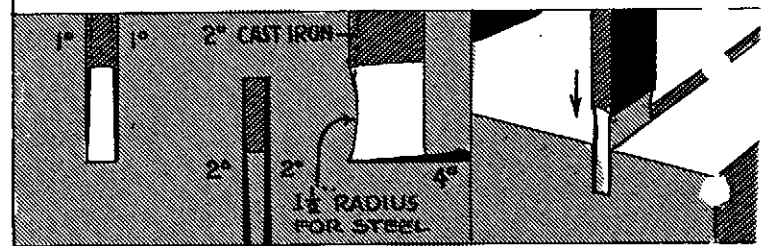

FIG. 248