

2 1

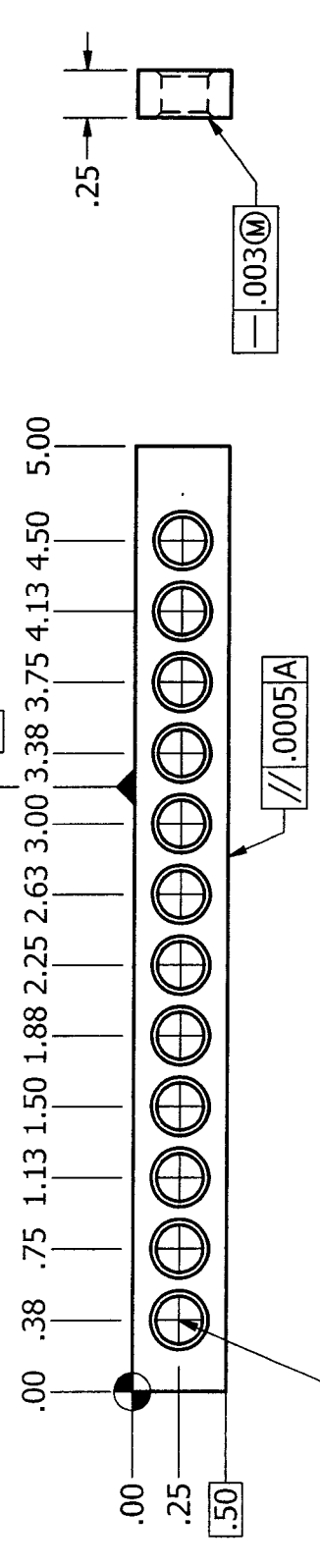
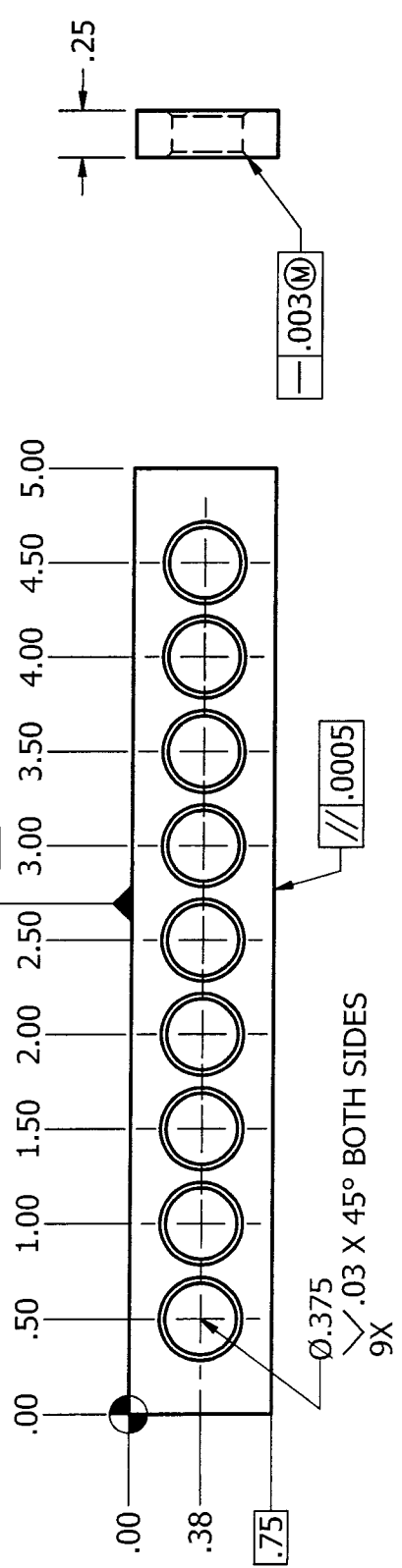

UNLESS OTHERWISE SPECIFIED  
 DIMENSIONS ARE IN INCHES  
 TOLERANCES ARE:  
 FRACTIONS DECIMALS  
 ±1/64 .XX ± .01  
 .XXX ± .005  
 DO NOT SCALE DRAWING

APPROVALS	DATE
DRAWN	5/01/09
CHECKED	
ENGR BONO	

CONNECTICUT TECHNICAL  
 HIGH SCHOOL SYSTEM

TITLE  
**3/4 AND 1/2 PARALLELS**

SIZE CAGE CODE 91747  
 DIM. NO. -  
 REV. -

SCALE: 1:1 1 OF 1

2

B

1

A

AISI 1020 CRS  
 CASE HDN.  $\nabla$  .02  
 2 EACH REQ.

2

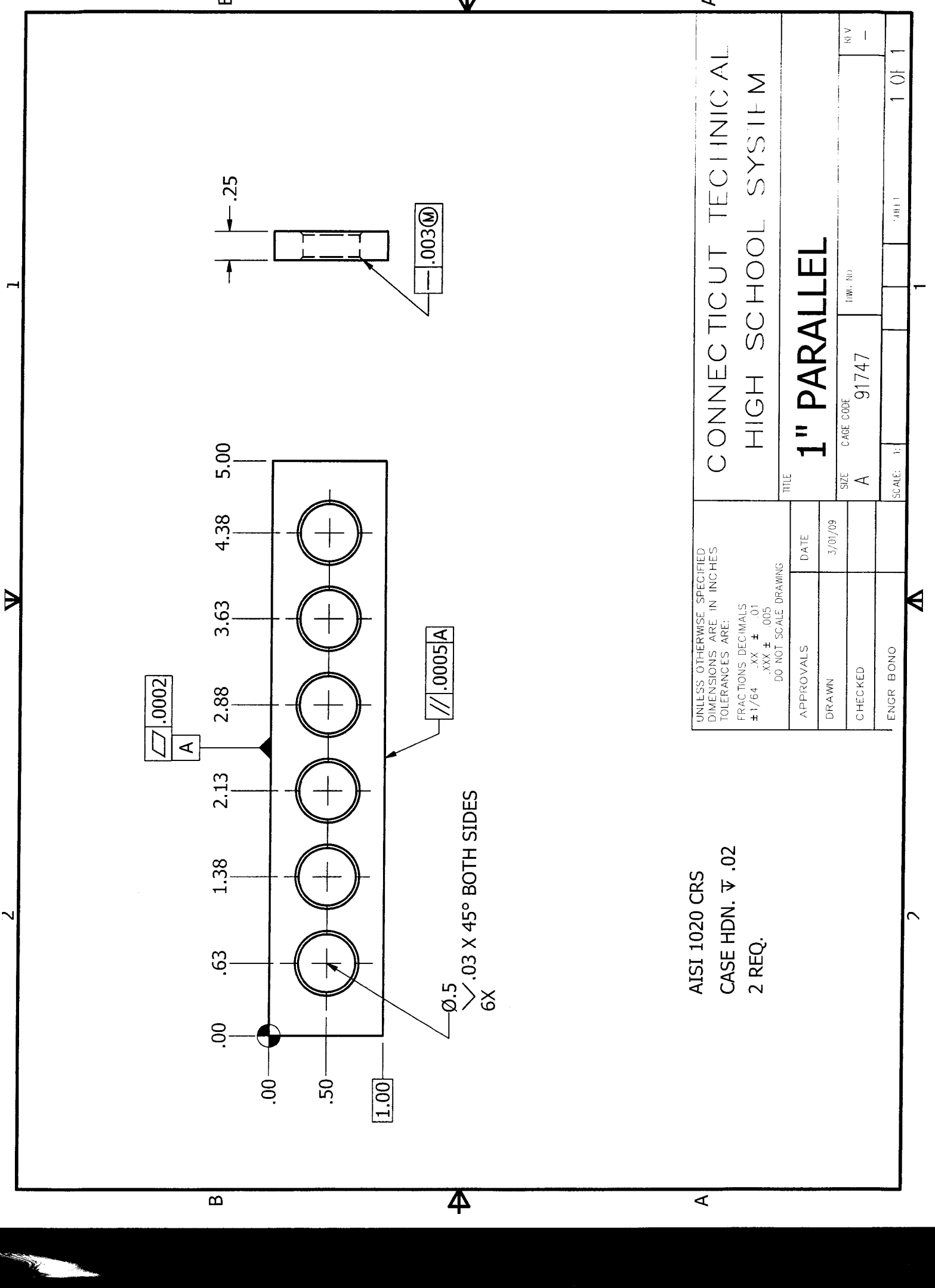

AISI 1020 CRS  
CASE HDN. ▽ .02  
2 REQ.

UNLESS OTHERWISE SPECIFIED  
DIMENSIONS ARE IN INCHES  
TOLERANCES ARE:  
FRACTIONS DECIMALS  
± 1/64 .XX ± .01  
.XXX ± .005  
DO NOT SCALE DRAWING

CONNECTICUT TECHNICAL  
HIGH SCHOOL SYSTEM

TITLE  
**1" PARALLEL**

APPROVALS	DATE
DRAWN	3/01/09
CHECKED	
ENGR BONO	

SIZE	CAGE CODE	DWG. NO.	REV.
A	91747		-

SCALE:	1:	1:	1:	1:
				1 0 1 1

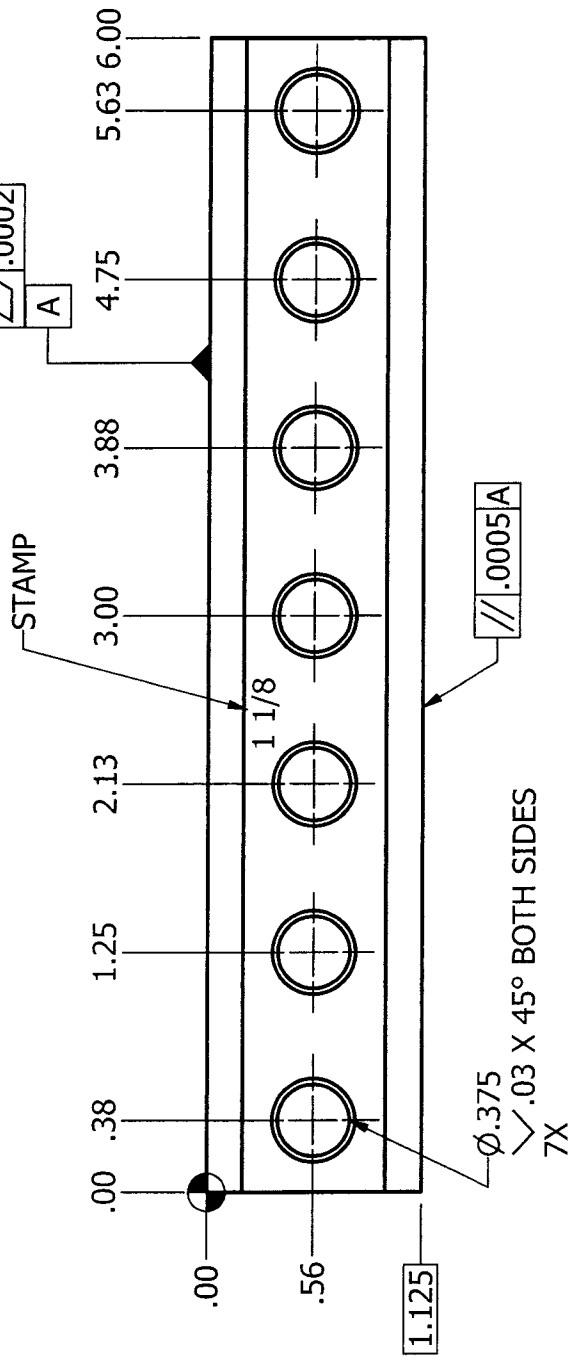
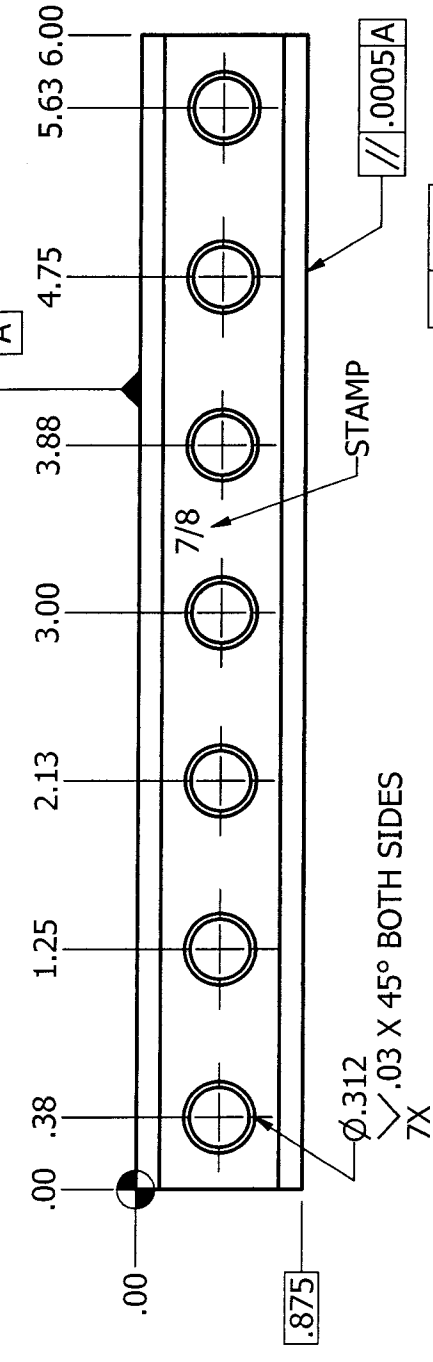
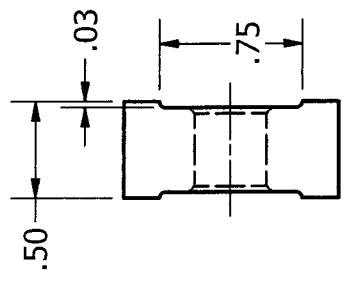
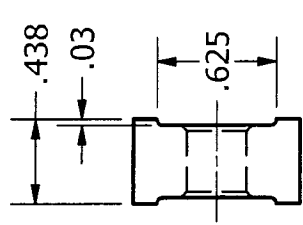

UNLESS OTHERWISE SPECIFIED  
DIMENSIONS ARE IN INCHES  
TOLERANCES ARE:  
±1/64 XX ± .01  
.XXX ± .005  
DO NOT SCALE DRAWING

APPROVALS	DATE
DRAWN <b>NICOLE A.</b>	3/01/09
CHECKED	
ENGR BONO	

CONNECTICUT TECHNICAL HIGH SCHOOL SYSTEM	
TITLE <b>7/8 &amp; 1 1/8 PARALLELS</b>	
SIZE A	DWG. NO. 91747
SCALE: 1:1	REV -
PAGE 1 OF 2	

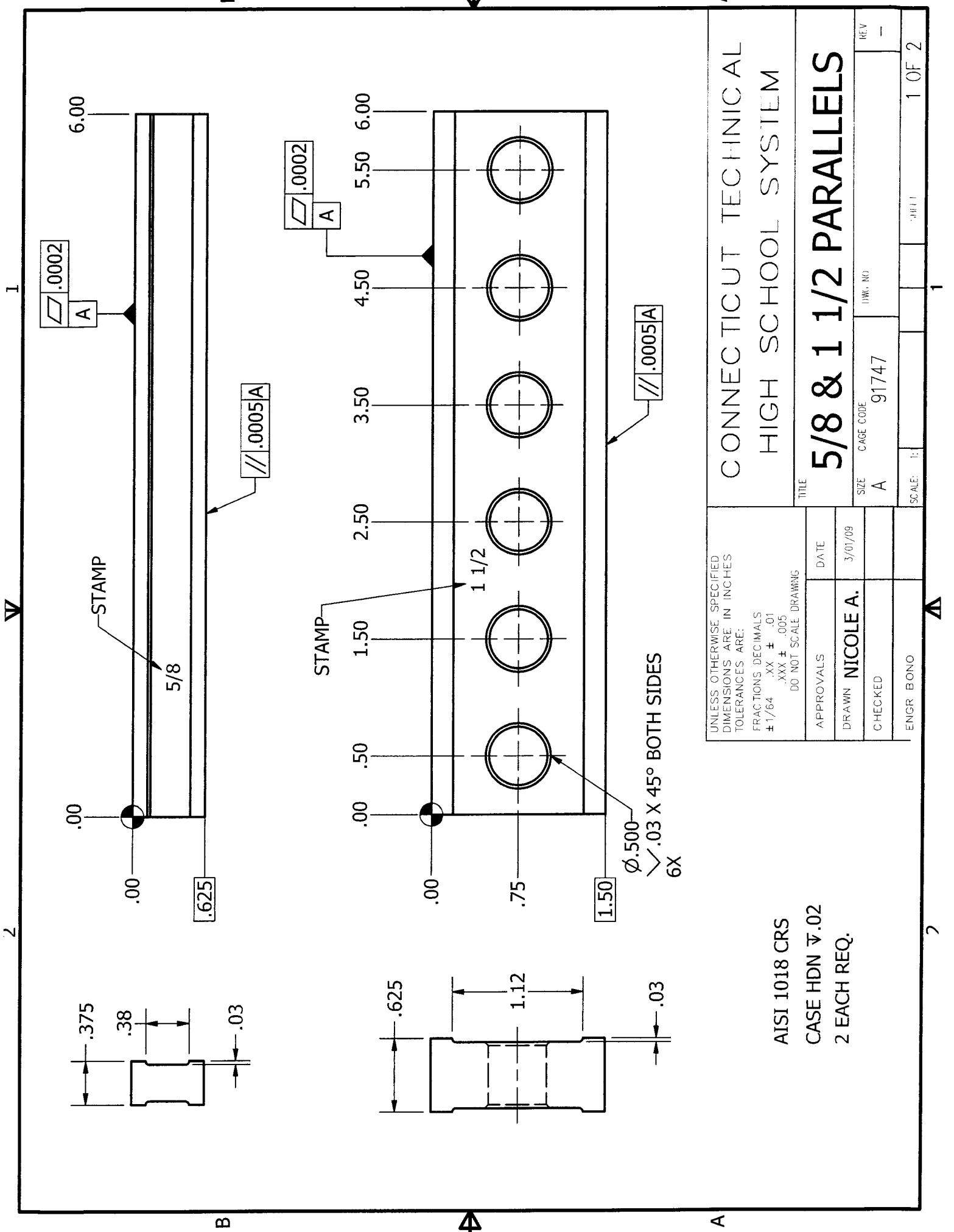

UNLESS OTHERWISE SPECIFIED  
DIMENSIONS ARE IN INCHES  
TOLERANCES ARE:  
FRACTIONS, DECIMALS  
±1/64 .XX ± .01  
.XXX ± .005  
DO NOT SCALE DRAWING

APPROVALS	DATE
DRAWN NICOLE A.	3/01/09
CHECKED	
ENGR BONO	

CONNECTICUT TECHNICAL  
HIGH SCHOOL SYSTEM

TITLE		5/8 & 1 1/2 PARALLELS	
SIZE	CAGE CODE	DWG. NO.	REV.
A	91747		-
SCALE:	1:		1 OF 2

AISI 1018 CRS  
CASE HDN ▽.02  
2 EACH REQ.

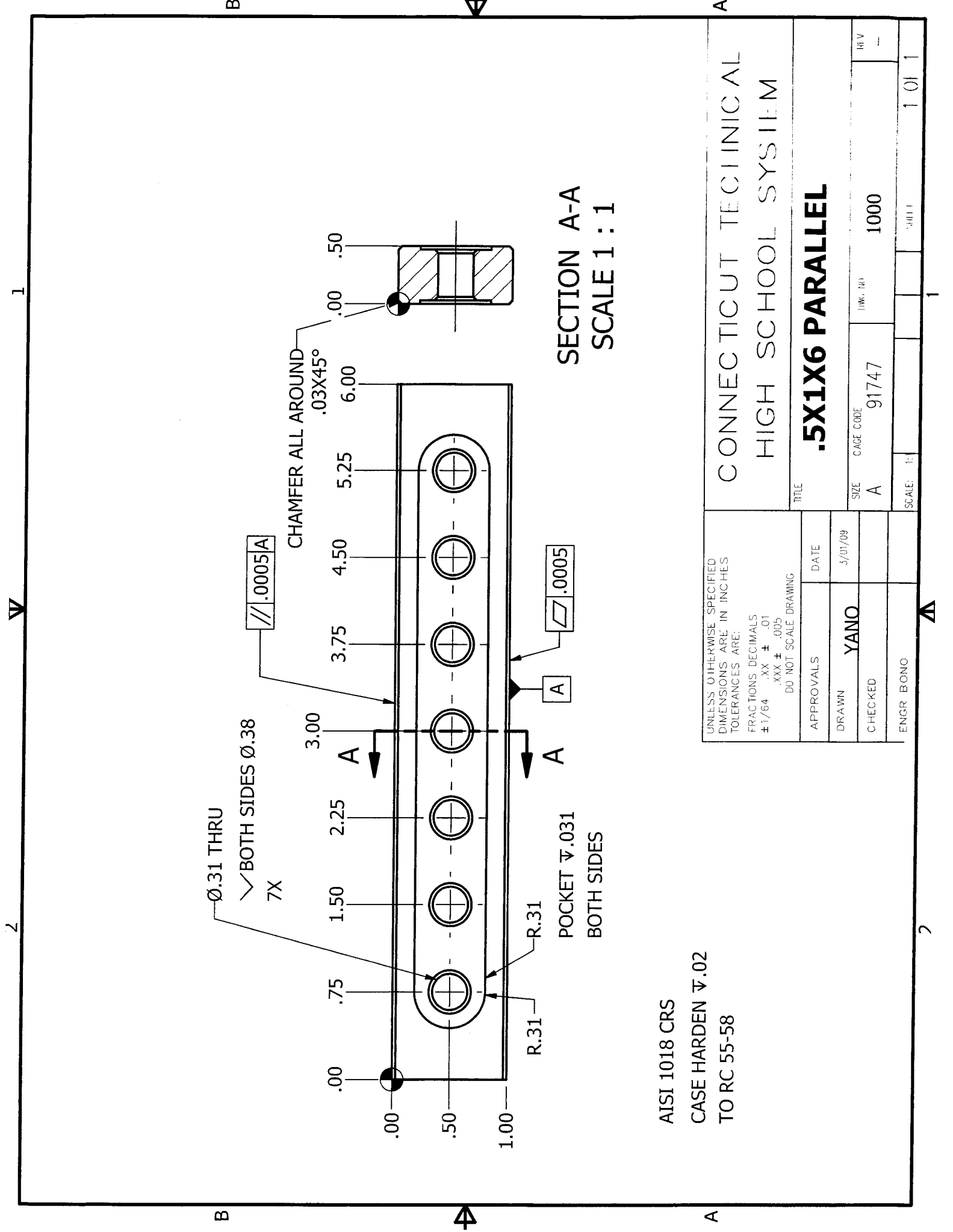

Ø.31 THRU  
 ✓ BOTH SIDES Ø.38  
 7X

CHAMFER ALL AROUND  
 .03X45°

SECTION A-A  
 SCALE 1 : 1

AISI 1018 CRS  
 CASE HARDEN  $\nabla$ .02  
 TO RC 55-58

UNLESS OTHERWISE SPECIFIED  
 DIMENSIONS ARE IN INCHES  
 TOLERANCES ARE:  
 FRACTIONS DECIMALS  
 $\pm 1/64$  .XX  $\pm$  .01  
 .XXX  $\pm$  .005  
 DO NOT SCALE DRAWING

APPROVALS	DATE
DRAWN <b>YANO</b>	5/01/09
CHECKED	
ENGR BONO	

CONNECTICUT TECHNICAL  
 HIGH SCHOOL SYSTEM

**.5X1X6 PARALLEL**

TITLE	
SIZE	1000
CAGE CODE	91747
DRW. NO.	
SCALE	1 : 1